



HIGH PERFORMANCE INDUSTRIAL VACUUMS

WHY USE AN INDUSTRIAL VACUUM?



Industrial vacuuming is a key element in ensuring cleanliness and efficiency in working environments. Dust, solids, liquids, and waste are indeed a common problem in industry, especially in sectors such as woodworking, cement and ceramic production, metallurgy, and mechanical engineering. Managing these waste materials is critical to ensuring a safe and clean work environment, and to maintaining high standards of efficiency and productivity.



FAST AND EFFICIENT CLEANING

of the workspace and its surroundings



SAFETY

for the workers and the work environment



PRODUCTIVITY

reducing accidents and downtimes

SAFETY FOR WORKERS AND WORK ENVIRONMENT



Breathe safely with the right vacuum for fine or hazardous dust. Using an industrial vacuum cleaner protects workers and the environment from fine or hazardous dust exposure. Depureco vacuums come standard with M-class filters for everyday protection. For the toughest jobs and the highest level of safety, you can upgrade to H-class filters. H-class filters capture even finer particles, ensuring maximum protection.



STURDY METAL CONSTRUCTION

Increased durability and suitability for heavy-duty tasks.



HIGH PERFORMANCES

Extensive selection of suction units to fit every specific application.



HIGH CUSTOMIZATION

Wide manufacturing optionals to satisfy specific requirements.

HOW IT WORKS?

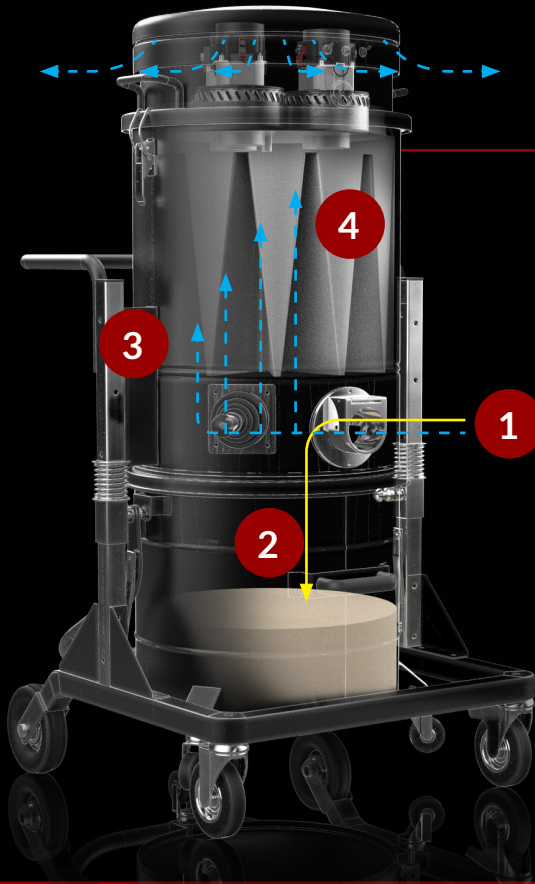

1. The dust get sucked into the inlet.
2. The dust particles fall downwards in to the collection system.
3. The air travels upward towards the vacuum filter and exits from the head.
4. The lighter particles get stuck on the filter surface protecting the motors.

● Dust ● Air

COMMON APPLICATIONS



Liquid spillage cleaning



Fine powder cleaning



Metal chips cleaning from a CNC machine



Height cleaning



Hot material cleaning



Floor cleaning

HOW TO CHOOSE?



SUCTION UNITS



SINGLE-PHASE MOTOR

Generate high vacuum performances, conceived for non-continuous use. Each motor is managed by an independent switch, allowing the operator to control suction performances.

- Powerful and highly reliable
- Long lasting life, up to 1300 hours

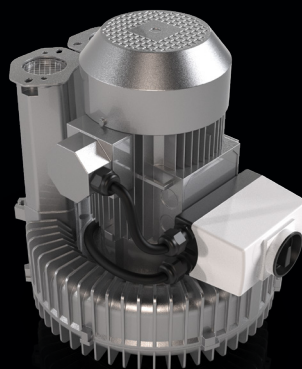

SIDE CHANNEL BLOWER

The suction unit is a side channel blower with direct coupling between motor and impeller. The side channel blower is equipped with a safety valve to guarantee continued work in complete safety, without any maintenance.

- Continuous duty 24h and 7 days per week
- No need of maintenance



BATTERY

Our 24 Volt batteries are the ultimate solution for powering our battery-powered Industrial Vacuum Cleaners. With these batteries, enjoy powerful suction capabilities without the constraints of an available power source.

- Mobility without compromises
- No need of a close power outlet

FILTRATION OPTIONS



M

Polyester filter for dust category M.

Filtration efficiency down to 1 μ .

Antistatic media available.



MTF

Polyester filter with Teflon coating, particularly suitable for very sticky materials.



NOMEX

High temperature resistant filter ideal for hot dust extraction.



PTFE

Teflon-blended polyester filter, particularly suitable for vacuuming up fine dust and sticky materials.

Antistatic media available.



HEPA 13

Absolute cartridge filter for very fine dust with high filtration efficiency.



HEPA 14

High-efficiency cartridge filter for fine dust, 99.995% at 0.18 μ .

CLEANING THE FILTERS

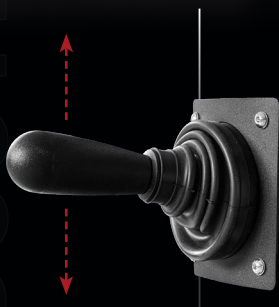

MANUAL

The vacuum cleaner is equipped with a lever connected directly to the filter. The vertical movement of the lever compresses the filter, causing the material to detach from the surface of the filter and fall into the container.

Available also with pneumatic shaker (PSC).



SP

Each filter cartridge is cleaned at adjustable intervals by a high-pressure (6 bar) air jet, which shakes the cartridge, dislodging large amounts of material from the filter, making it completely clean in a matter of seconds.

It requires compressed air to operate.

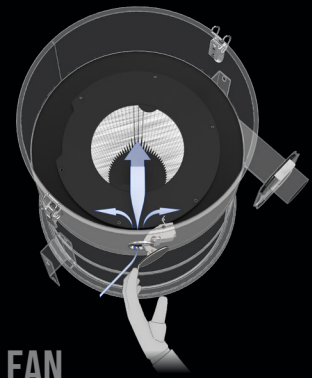

JET-CLEAN

The JetClean® System uses the pressure differential between the inside and outside of the vacuum cleaner to perform fast and effective cleaning, without having to switch off the vacuum cleaner.

Coupled with SD guillotine to interrupt suction.

COLLECTION SYSTEMS



DROP-DOWN BIN

Easy to detach and made by steel or stainless steel, the detachable bin allows easy management of the collected material.













ENDLESS BAG

The Endless Bag roll system offers a safe and efficient solution for collecting and disposing of fine and toxic dust. This continuous system prevents operator contact with hazardous materials.

OVERVIEW











				
	XM 20	XM 20 JETCLEAN	XM 35 JETCLEAN	MINIBULL
POWER SUPPLY	 120 V	 120 V	 120 V	 120 V
MOTORS	 Two motors	 Two motors	 Two motors	 Two motors
USE	Non-continuous use Dust	Non-continuous use Dust	Non-continuous use Dust + Liquids	Non-continuous use Dust + Liquids
FILTER CLEANING	Manual	JetClean semi automatic	JetClean semi automatic	Manual
COLLECTION	6 gal Bin	6 gal Bin	12 gal Bin or Endless bag	12 gal Bin









				
	M 100	M 100 JETCLEAN TAN	BULL 24	FOX 24
POWER SUPPLY	 120 V	 120 V	 Battery 24 V	 Battery 24 V
MOTORS	 Three motors	 Three motors	 Three motors	 Three motors
USE	Non-continuous use Dust + Liquids	Non-continuous use Dust + Liquids	Non-continuous use Dust + Liquids	Non-continuous use Dust + Liquids
FILTER CLEANING	Manual	JetClean semi automatic	Manual	Manual
COLLECTION	26 gal Bin or Endless bag	26 gal Bin or Endless bag	26 gal Bin	26 gal Bin



	WD	WD PUMP	TB	TB UP
POWER SUPPLY	 120 V	 120 V	 480 V	 480 V
MOTORS	 Two or three motors	 Two motors	 Side channel blower	 Side channel blower
USE	Non-continuous use Liquids	Non-continuous use Liquids + simultaneous suction and discharge	Continuous use Dust + Liquids	Continuous use Dust + Liquids
FILTER CLEANING	-	-	Manual	Manual
COLLECTION	34 gal Container	34 gal Container	12 gal Bin	12 gal Bin



	ECOBULL	TX	FOX	PUMA
POWER SUPPLY	 480 V	 480 V	 480 V	 480 V
MOTORS	 Side channel blower	 Side channel blower	 Side channel blower	 Side channel blower
USE	Continuous use Dust + Liquids	Continuous use Dust + Liquids	Continuous use Dust + Liquids	Continuous use Dust
FILTER CLEANING	Manual	Manual	Manual	Manual or "SE" Electric filter shaker
COLLECTION	17/26 gal Bin or Endless bag	26 gal Bin or Endless bag	26 gal Bin or Endless bag	46 gal Bin

XM 20



Power: 2.7 HP



Capacity: 6 gal



Filtering surface: 2,500 in²



Dimensions: in 20.31 X 21.46 X 39.13 h



2 By-Pass motors



M-Class filter



Manual filter shaker



Kit HEPA filter (H14)

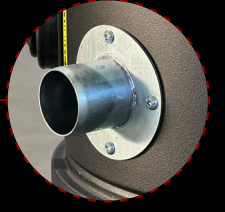

50 mm inlet with deflector



6 gal bin capacity

Code: A1400-001

XM 20 JETCLEAN



Power: 2.7 HP



Capacity: 6 gal



Filtering surface: 5,500 in²



Dimensions: in 20.31 X 21.46 X 39.13 h

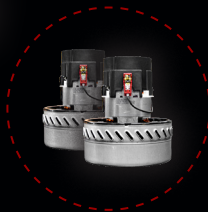

2 By-Pass motors



JetClean® filter cleaning system



Conical M-Class filter cartridge



Kit HEPA filter (H14)



50 mm inlet with sliding damper



6 gal bin capacity

Code: A1400

XM 35 JETCLEAN

Code: A1420



2 By-Pass motors



JetClean® filter
Cleaning system

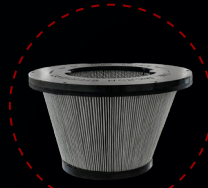

Conical M-Class
filter cartridge



Kit HEPA filter (H14)



50 mm inlet with
sliding damper



12 gal bin capacity



Endless bag available

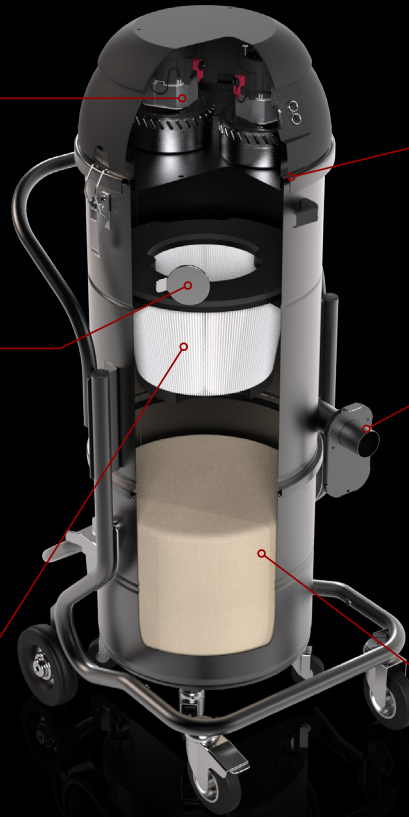

Power: 2.7 HP



Capacity: 12 gal



Filtering surface: 5,500 in²



Dimensions: mm 23 X 21.5 X 50.6 h

MINIBULL

Code: A715



2 By-Pass motors



M-Class filter



Manual filter shaker



Kit HEPA filter (H14)



70 mm inlet with
deflector



12 gal bin capacity

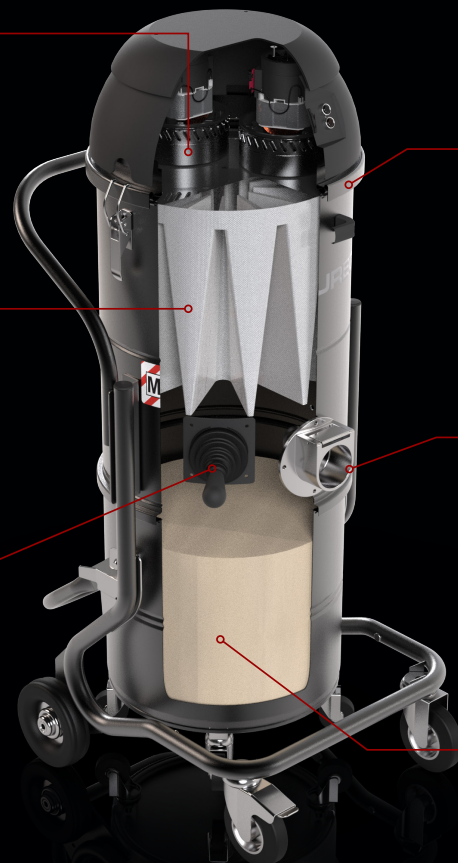

Power: 2.7 HP



Capacity: 12 gal



Filtering surface: 2,500 in²



Dimensions: in 21.7 X 24.4 X 48.8h

M100

Codes: A039/US

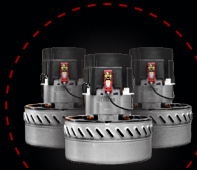

3 By-Pass motors



M-Class filter

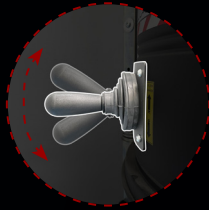

Manual filter shaker

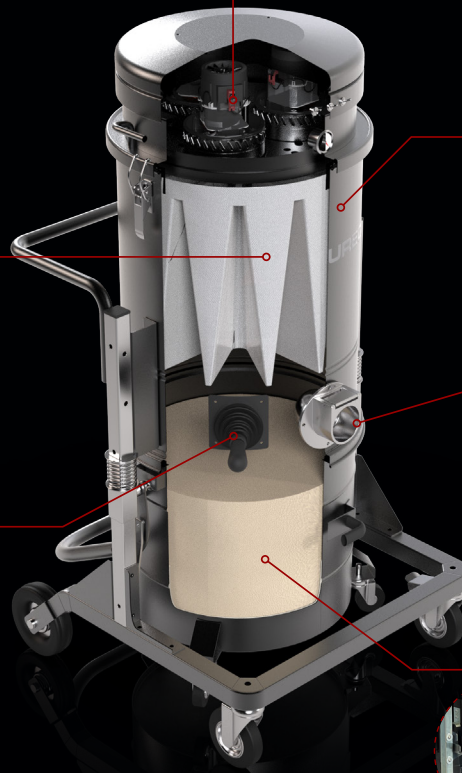

Kit HEPA filter (H14)



70 mm inlet with deflector



26 gal bin capacity

Endless bag available



Power: 3.3 HP



Capacity: 26 gal



Filtering surface: 3,800 in²



Dimensions: in 26 X 31.1 X 59.6 h

M100 JetClean TAN[®]

Codes: A1560

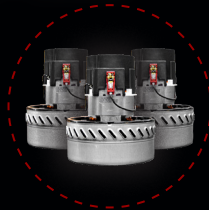

3 By-Pass motors



JetClean® filter cleaning system



Conical M-Class filter cartridge

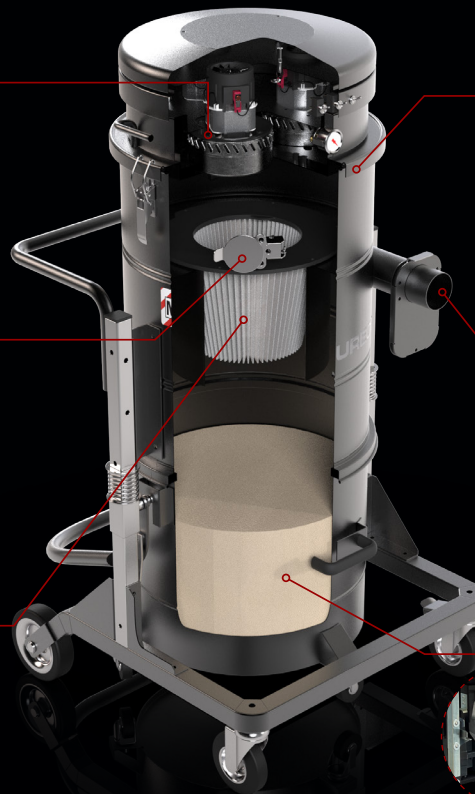

Kit HEPA filter (H14)

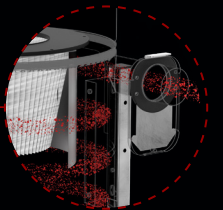

70 mm tangential inlet with cyclone



26 gal bin capacity

Endless bag available



Power: 3.3 HP



Capacity: 26 gal



Filtering surface: 3,800 in²



Dimensions: in 26 X 31.1 X 59.6 h

BULL 24

Code: A368



3 By-Pass motors



M-Class filter



24 volt batteries

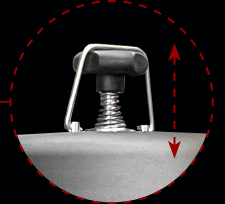
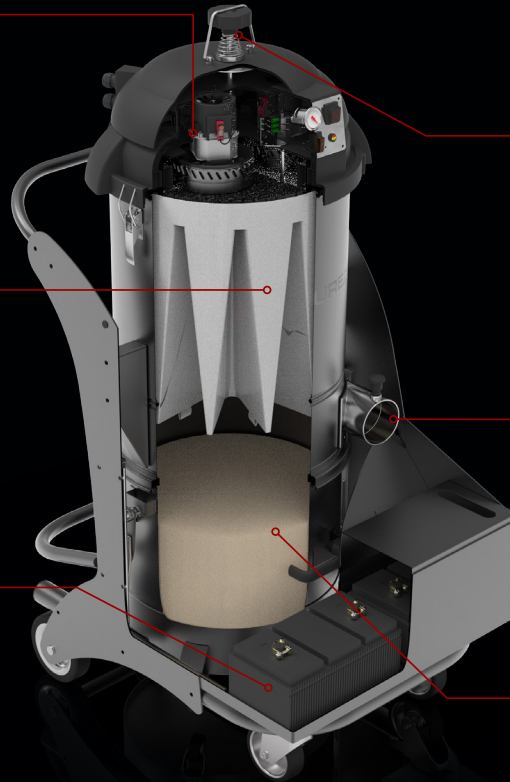

Manual filter shaker

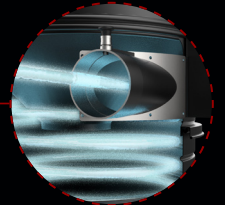

80 mm tangential inlet with cyclone



26 gal bin capacity



Power: 2 HP



Capacity: 26 gal



Filtering surface: 23,800 in²



Dimensions: in 24 X 14 X 10 h

FOX 24

Code: A410

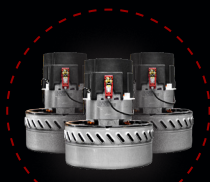

3 By-Pass motors



M-Class filter



24 volt batteries

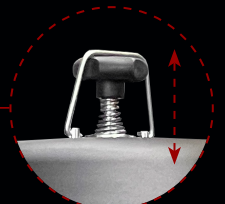
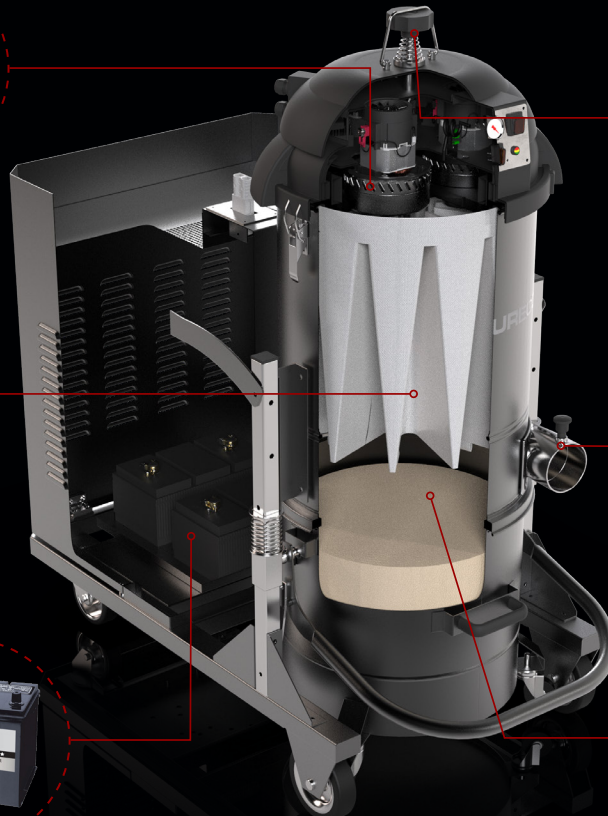

Manual filter shaker

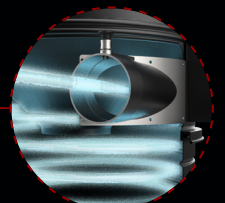

80 mm tangential inlet with cyclone



26 gal bin capacity



Power: 2 HP



Capacity: 26 gal



Filtering surface: 3,800 in²



Dimensions: in 24 X 14 X 10 h

WD 132/133

Codes: **A1571/A1572**

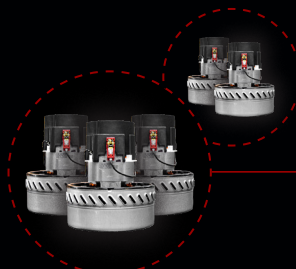

2 or 3 By-Pass motors

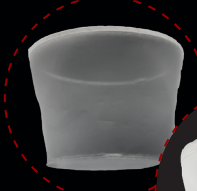

Solid filter



Liquid filter

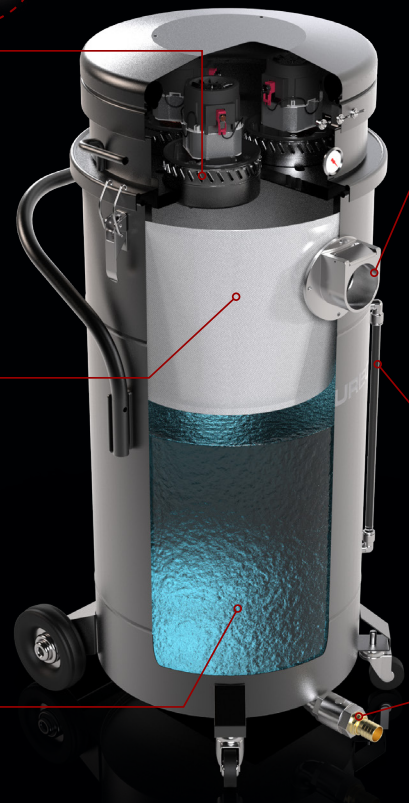

70 mm inlet with deflector



Liquid level indicator



Discharging tap



Power: from 2.7 to 3.3 HP



Capacity: 34 gal



Dimensions: in 22.8 X 20.9 X 45.7 h

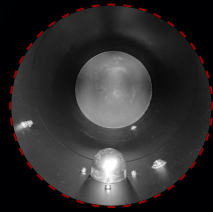

34 gal capacity

WD 132 P

Code: **A1570**



2 By-Pass motors

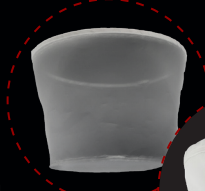

Solid filter



Liquid filter



Internal discharge pump

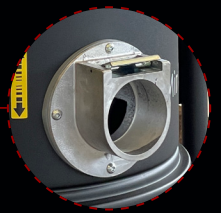
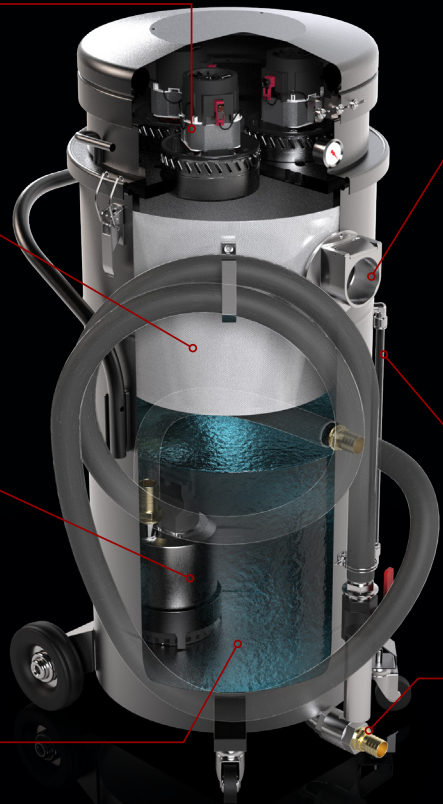

70 mm inlet with deflector



Liquid level indicator



Discharging tap



Power: from 2.7 to 3.3 HP



Capacity: 34 gal



Dimensions: in 22.8 X 20.9 X 45.7 h



34 gal capacity

TB 18/22

Codes: A923/US | A940/US



Side channel blower



M-Class filter



Manual filter shaker

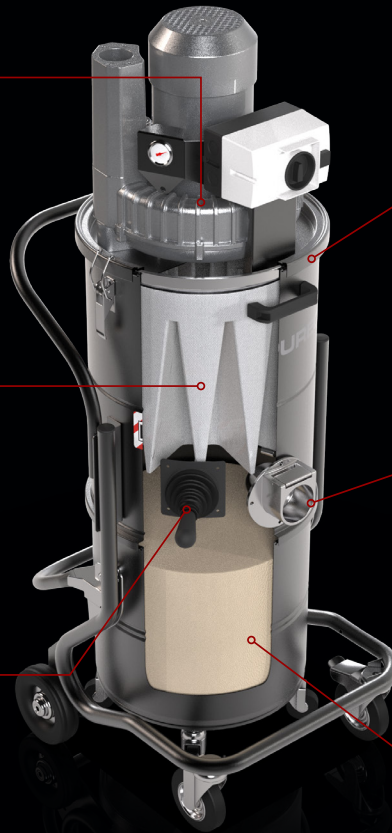

Kit HEPA filter (H14)



70 mm inlet with deflector



12 gal bin capacity

- Power: 3/3.5 HP
- Capacity: 12 gal
- Filtering surface: 2,500 in²
- Dimensions: in 21.6 X 24.4 X 53.3 h

TB UP 3

Codes: A878/US



M-Class filter



Side channel blower

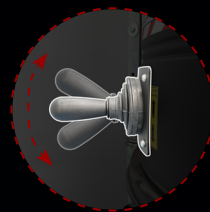

Manual filter shaker

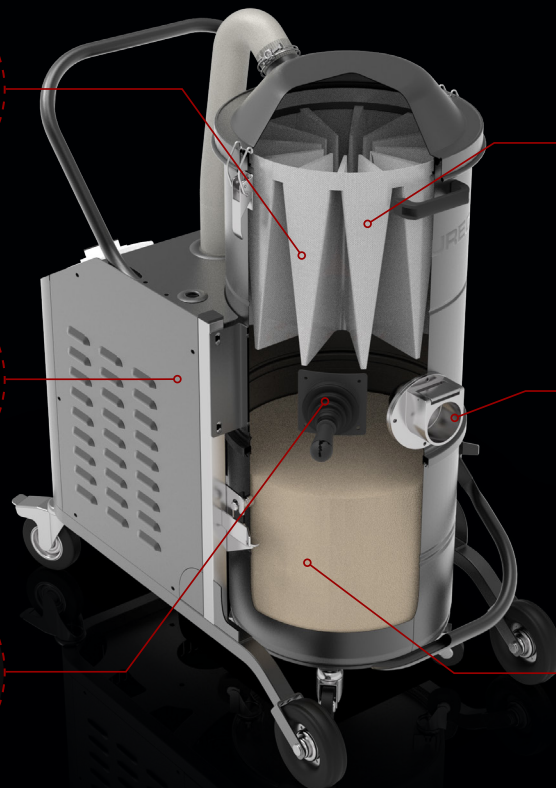

Kit HEPA filter (H14)



70 mm inlet with deflector



12 gal bin capacity

- Power: 3.5 HP
- Capacity: 12 gal
- Filtering surface: 2,500 in²
- Dimensions: in 21.6 X 35.4 X 44 h

ECOBULL T | PLUS

Codes: A995-001 | A1006/US



Side channel blower



M-Class filter

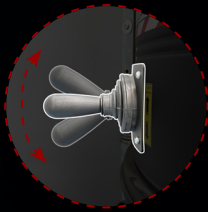

Manual filter shaker



Kit HEPA filter (H14)



70 mm inlet with deflector



26 gal bin capacity

Endless bag available



Power: from 4.8 to 6.5 HP



Capacity: 26 gal



Filtering surface: 3,800 in²



Dimensions: in 26 X 31.5 X 60.3 h

TX

Codes: A1500/US | A1486/US | A1487/US | A1488 | A1490/US



M-Class filter



Side channel blower

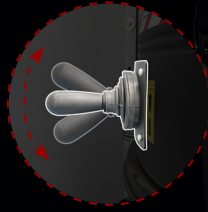

Manual filter shaker

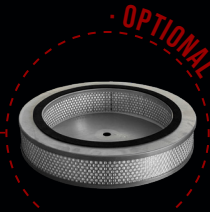

Kit HEPA filter (H14)



70 mm inlet with deflector



26 gal bin capacity

Endless bag available



Power: from 4.8 to 11.5 HP



Capacity: 26 gal



Filtering surface: 5,900 in²



Dimensions: in 25.6 X 43.3 X 55.1 h

PUMA

Codes: A500/US | A540/US | A560/US | A571/US | A557 | A574

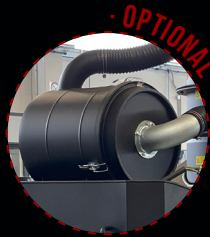

Kit HEPA filter (H14)



Side channel blower



46 gal bin capacity

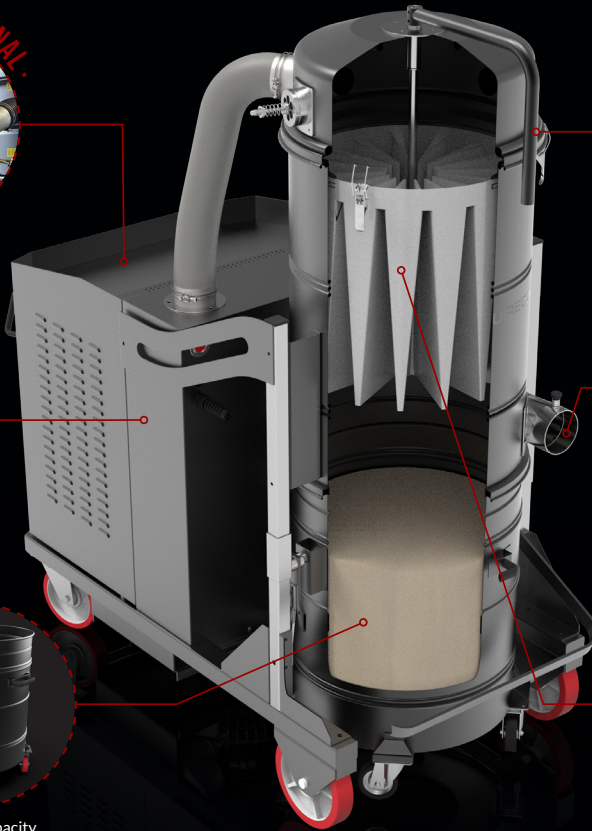

Manual filter shaker

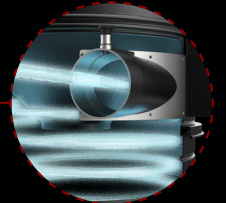

80 mm tangential inlet with cyclone



M-Class filter

- Power: from 11.5 to 28.6 HP
- Capacity: 46 gal
- Filtering surface: 7,000 in²
- Dimensions: in 33.5 X 61 X 78 h



PUMA

Codes: A600/A610/A619/A624

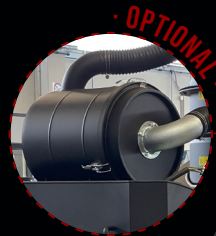

Kit HEPA filter (H14)

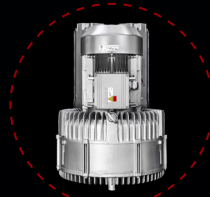

Side channel blower



46 gal bin capacity

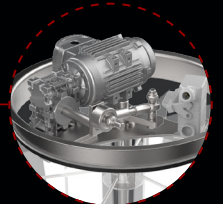

"SE" Electric filter shaker

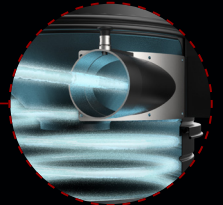

80 mm tangential inlet with cyclone



M-Class filter



Power: from 30 to 39 HP



Capacity: 46 gal



Filtrating surface: 17,100 in²



Dimensions: in 41.3 X 76.8 X 90.5 h

PRE-SEPARATORS

Unlock the full potential of your industrial vacuum with a pre-separator by its side. By adding a pre-separator to your setup, you're not only boosting capacity but also safeguarding your vacuum's filter, extending its lifespan. Together, they tackle even the toughest tasks, effortlessly handling a wider range of materials. With a separator your vacuum it's a solution tailored to solve any cleaning challenge with ease.



CAPACITY



DURABILITY



CENTRALIZED VACUUM SYSTEMS

- + MULTIPLE SUCTION POINTS
- + EFFICIENCY



Centralized vacuum systems revolutionize industrial cleaning operations with superior suction power, noise reduction, and ergonomic benefits. They streamline maintenance, ensure consistent performance, and promote better air quality, ultimately enhancing efficiency and productivity in the workplace.

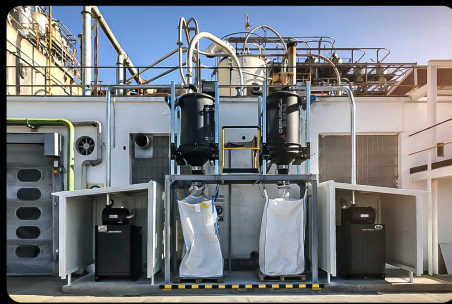

DUST EXTRACTORS FOR FLOOR PREPARATION



Depureco offers a wide range of dust extractors designed for surface treatment applications. Equipped with a large filter surface and an H14 HEPA filter, they capture even the finest dust particles. The continuous automatic filter cleaning system ensures consistent suction performance, while dust is conveniently collected in an endless bag for safe and easy disposal.

- Maximum protection against fine and silica dust, thanks to 2 stages of filtration up to 0.18µ efficiency with HEPA 14 filter.
- Safe dust collection, thanks to the Longopac bagging system
- Easy to transport and connect to other working equipment such as floor grinders or scarifiers.

SCAN THE QR-CODE!

and discover the dedicated catalog for the floor preparation range from Depureco.



SUMP VACUUMS FOR OIL & CHIPS



Depureco offers a dedicated range of industrial vacuums for oil and chips extraction. With high suction capacity, they efficiently separate liquids from metal chips, ensuring continuous operation. Clean oil can be discharged easily, making the process faster, safer, and more efficient.

Vacuum cleaners for cleaning CNC tanks in the metalworking industry.

- Separation of oil from metal chips and reuse of filtered oil.
- Reduction of machine downtime and maintenance time.
- Tank capacities from 18 up to 264 gal.

SCAN THE QR-CODE!

and discover the dedicated catalog for the oil & chips range from Depureco.



MAIN UPGRADES

H14 FILTRATION



P12279
22000 H14
HEPA Filter

P09868
28000 H14
HEPA Filter

P11640
22000 H14
HEPA Filter

P11363
110000 H14
HEPA Filter

TILTABLE KIT FOR BIN

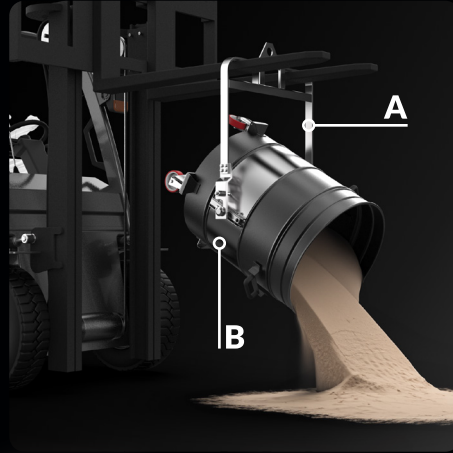

P01033
26 gal | Lift bracket "A"

P01034
46 gal | Lift bracket "A"

P11287
26 gal | Ring for bin
installation "B"

P00273
46 gal | Ring for bin
installation "B"

FLOOR CLEANING FIXED TOOL



P00327
Fixed kit for floor
cleaning Ø40

P11792
Fixed kit for floor
cleaning Ø70

BAGGING SYSTEM



P09252
Bag holder for
disposable bag

LOCALIZED SUCTION



P14025
Quick release
articulated arm Ø70

LIQUIDS SUCTION

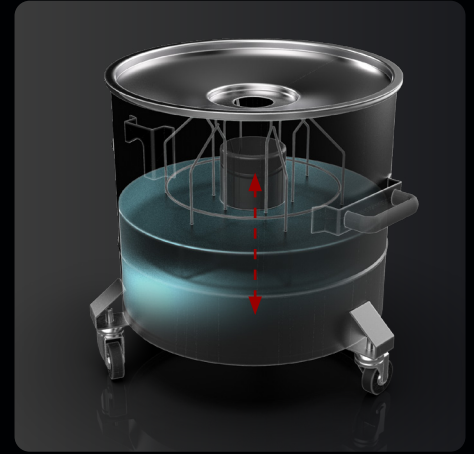

P12005
Floating device 12 gal

P12004
Floating device 17 gal

ACCESSORIES

KITS



P13638
Starter kit Ø40



P13639
Wet & Dry kit Ø40



P11887
Wet & Dry kit Ø50



P12350
Starter kit Ø50



P13640
Dry kit Ø40



P12348
Dry kit Ø50



P14048/5
Dry kit Ø70



P14052
Height cleaning kit
Ø40



P14050/5
Heavy duty starter
kit Ø70



P14049/5
Heavy duty kit PRO
Ø70



P14053
Height cleaning kit
Ø50



P14051/5
Bulk kit Ø70

P11857
Oven cleaning kit Ø40

OPTIONS



BX - GX - TX

BX - stainless steel container.
GX - Stainless steel container and filter chamber.
TX - Stainless steel container, filter chamber and structure.



FKL

Prepared for forking and lifting by forklift truck.



GFR

Ringbolts placed on the structure of the vacuum cleaner to facilitate lifting.



AB

Accessory basket.



GRD

All conductive vacuum cleaner components are connected and earthed to discharge electrostatic charges.



PRV

Pressure relief valve that prevents overpressure and overheating, ensuring safety and durability of the suction unit.



TAN

Tangential inlet. The cyclone inside slows down the sucked material and makes it fall into the container due to the cyclonic effect.



KDP

Kit to keep the disposable bag in stretch.



RC

Schuko 24 VAC socket for power supply and remote control from power tools.



LR

Predisposition for remote control connection.



WRLS

Switching on and off via wireless remote control.



SPARK TRAP

Safety system that prevents sparks, even burning sparks, from reaching the inside of the vacuum cleaner.

OTHER PRODUCTS FROM DEPURECO



INDUSTRIAL VACUUMS FOR OIL & SWARF

Industrial vacuums engineered to ease and speed up CNC machineries maintenance.



COMPRESSED AIR INDUSTRIAL VACUUMS

Industrial vacuum cleaners that can be used with the aid of compressed air where electricity is not allowed or missing



DUST COLLECTORS

Industrial vacuum cleaners for the recovery of volatile or suspended dust.



INDUSTRIAL VACUUMS FOR FOOD, PHARMA & OEM

Industrial vacuum cleaners dedicated to on-board machine use and integration.



INDUSTRIAL VACUUMS FOR FLOOR PREPARATION

Industrial vacuum cleaners dedicated to cleaning fine and hazardous dust during surface treatment processes.



INDUSTRIAL VACUUMS FOR WELDING FUMES

Dedicated to safe and localized extraction of welding fumes.



CENTRAL VACUUM SYSTEMS

Centralized vacuum systems for cleaning large workplaces with multiple suction points and integration into the production process.

DATA SHEET

SINGLE-PHASE



		XM 20	XM 20 JC	XM 35 JC	MINIBULL	M65/100	M65/100 JC TAN	BULL 24	FOX 24	WD 132	WD 132 P	WD 133
Code		A1400-001	A1400	A1420	A715	A032/A039	A1550/A1560	A368	A410	A1571	A1570	A1572
Code with Endless bag		-	-	A1421	-	A1565	A1551	-	-	-	-	-
Power	HP	2.7	2.7	2.7	2.7	3.3	3.3	2	2	2.7	2.7	3.3
Voltage / Frequency	V Hz	120 60	120 60	120 60	120 60	120 60	120 60	24	24	120 60	120 60	120 60
IP		-	-	-	-	-	-	-	-	-	-	-
Maximum vacuum	inH2O	94	94	94	94	98	98	94	94	94	94	98
Maximum air flow	CFM	230	230	230	230	336	336	206	206	230	230	336
Inlet	Ømm	50	50	50	50	70/central	70/tangential	80/tangential	80/tangential	70	70	70
Noise level	dB(A)	72	72	72	72	72	72	64	64	72	72	72
Bin capacity	gal	6	6	12	12	26	26	26	26	34	34	34
Dimensions	in	20.31 X 21.46	20.31 X 21.46	23 X 21.5	21.7 X 24.4	26 X 31.1	26 X 31.1	25.6 X 33.5	26 X 47.2	22.8 X 20.9	22.8 X 20.9	22.8 X 20.9
Height	in	39.13	39.13	50.6	48.8	59.6	59.6	55.1	55.1	45.7	45.7	45.7
Weight	lbs	84	84	99	99	176	176	165	220	84	104	88
Primary filter												
Surface	in ²	2500	5500	5500	2500	3800	3800	3800	3800	-	-	-
Class EN 60335-2-69	IFA BG AM-PES	M Class	M Class	M Class	M Class	M Class	M Class	M Class	M Class	-	-	-
Media		Polyester	PTFE Coated polyester	PTFE Coated polyester	Polyester	Polyester	PTFE Coated polyester	Polyester	Polyester	PPL nylon polypropylene	PPL nylon polypropylene	PPL nylon polypropylene
Filter cleaning		Manual	JetClean	JetClean	Manual	Manual	JetClean	Manual	Manual	-	-	-

THREE-PHASE

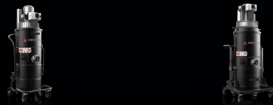

		TB 18 M	TB 22	ECOBULL T	ECOBULL PLUS
Code		A923/US	A940/US	A995-001	A1006/US
Power	HP	3	3.5	4.8	6.5
Voltage / Frequency	V Hz	480 60	480 60	480 60	480 60
IP		55 F	55 F	55 F	55 F
Vacuum in continuous	inH2O	85	85	108	115
Maximum air flow	CFM	160	160	247	247
Inlet	Ømm	70	70	70	70
Noise level	dB(A)	74	74	72	72
Bin capacity	gal	12	12	26	26
Dimensions	in	21.6 X 24.4	21.6 X 24.4	26 X 31.5	26 X 31.5
Height	in	53.3	53.3	60.2	60.2
Weight	lbs	110	121	194	209
Primary filter					
Surface	in ²	3500	3500	4400	4400
Class EN 60335-2-69	IFA BG AM-PES	M Class	M Class	M Class	M Class
Media		Polyester	Polyester	Polyester	Polyester
Filter cleaning		Manual	Manual	Manual	Manual

DATA SHEET

THREE-PHASE



		TB UP 3	TX 300	TX 400 P	TX 400 S	TX 550 P	TX 750
Code		A878/US	A1500/US	A1486/US	A1487/US	A1488	A1490/US
Code with Endless bag		-	A1505	A1479	A1474	A1519	A1466
Power	HP	3.5	4.8	6.5	6.5	5.5 - 7.5	7.5 - 10
Voltage / Frequency	V Hz	480 60	480 60	480 60	480 60	480 60	480 60
IP		55 F	55 F	55 F	55 F	55 F	55 F
Vacuum in continuous	inH2O	108	108	160	360	260	260
Maximum air flow	CFM	247	247	530	330	530	730
Inlet	Ømm	70	70	70	70	70	70
Noise level	dB(A)	72	74	76	76	76	79
Bin capacity	gal	12	26	26	26	26	26
Dimensions	in	21.6 X 35.4	25.6 X 43.3	25.6 X 43.3	25.6 X 43.3	25.6 X 43.3	25.6 X 43.3
Height	in	44	55.1	55.1	55.1	55.1	55.1
Weight	lbs	176	287	309	309	389	419
Primary filter							
Surface	in²	2500	5900	5900	5900	5900	5900
Class EN 60335-2-69	IFA BGIAM-PES	M Class	M Class	M Class	M Class	M Class	M Class
Media		Polyester	Polyester	Polyester	Polyester	Polyester	Polyester
Filter cleaning		Manual	Manual	Manual	Manual	Manual	Manual

HEAVY-THREEPHASE



		PUMA 10	PUMA 15 P	PUMA 15 S	PUMA 18 S	PUMA 20	PUMA 25	PUMA 30 P	PUMA 30 S	PUMA 35 P	PUMA 35 S
Code		A500/US	A540/US	A560/US	A571/US	A557	A574	A600	A610	A619	A624
Power	HP	11.5	17.5	23.2	16.9	23.2	28.6	30	30	39	39
Voltage / Frequency	V Hz	480 60	480 60	480 60	480 60	480 60	480 60	480 60	480 60	480 60	480 60
IP		55 F	55 F	55 F	55 F	55 F	55 F	55 F	55 F	55 F	55 F
Vacuum in continuous	inH2O	100	110	200	110	130	137	64	176	110	176
Maximum air flow	CFM	490	660	364	520	660	940	1354	776	1430	776
Inlet	Ømm	100	100	100	100	100	100	130	130	130	130
Noise level	dB(A)	74	74	74	74	74	74	78	78	78	78
Bin capacity	Lt	46	46	46	46	46	46	46	46	46	46
Dimensions	in	33.5 X 61	33.5 X 61	33.5 X 61	33.5 X 61	33.5 X 61	33.5 X 61	41.3 X 76.8	41.3 X 76.8	41.3 X 76.8	41.3 X 76.8
Height	in	78	78	78	78	78	78	90.5	90.5	90.5	90.5
Weight	lbs	650	595	800	783	639	816	1235	1367	1442	1433
Primary filter											
Surface	in²	18600	18600	18600	18600	18600	18600	27900	27900	27900	27900
Class EN 60335-2-69	IFA BGIAM-PES	M Class	M Class	M Class	M Class	M Class	M Class	M Class	M Class	M Class	M Class
Media		Polyester	Polyester	Polyester	Polyester	Polyester	Polyester	Polyester	Polyester	Polyester	Polyester
Filter cleaning		Manual	Manual	Manual	Manual	Manual	Manual	Manual	Manual	Manual	Manual



SPECIALTY



19121 Marketplace Avenue
Building 1, Suite 165
Plum Creek Business Park
Kyle, Texas 78640

Phone 737 70 44 347
www.depurecousa.com
info@depurecousa.com

