

OIL & SWarf
INDUSTRIAL
VACUUMS



WHY USE AN INDUSTRIAL VACUUM?

Industrial manufacturing processes that involve metal cutting produce residual swarf mixed with cutting oil or lubricants that are commonly collected into tanks. Using an industrial vacuum for separating cutting oil and swarf is a practical and efficient solution for managing this material, allowing easy separation and collection for recycling or safe disposal. This helps to maintain a clean and safe work environment, improve machinery efficiency, and reduce the overall environmental impact of industrial manufacturing processes.



Hydraulic oils

Clean lubricants

Mud and swarf

CLEAN AND REUSE



Recovery and reuse of clean lubricants, coolants and cutting oil



Saving on oil purchase and chips disposal costs



Maintenance time reduction and avoid downtimes



WORKING PRINCIPLE

WITH BIN

1. The oil and the swarf get sucked into the inlet.
2. The mixture travels around the cyclone in a circular motion.
3. The swarf gets separated from the oil with a metal basket and a PPL filter with 150 μ efficiency.
4. The clean oil gets collected in the metal bin.
5. The oil can easily be discharged to be collected and reused.
6. The air passes through an oil proof filter that traps the oil mist and protects the motors.

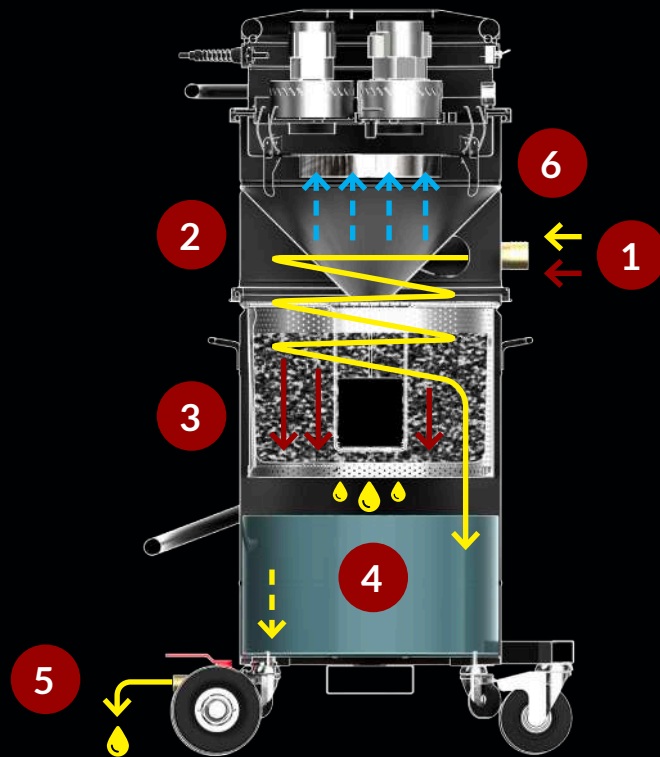

● Swarf ● Lubricant ● Air

WITH TANK

1. The oil and the swarf get sucked into the inlet.
2. The swarf gets separated from the oil in the metal basket.
3. The Oil it's collected into the vacuum tank.
4. The submerged pump blows out the oil.
5. The oil goes out of the tank to be collected and reused.
6. The air passes through an oil proof filter that protects the motorhead from oil mists.
7. The filtered air gets to the side channel blower.
8. The air is blown out clean in the environment.

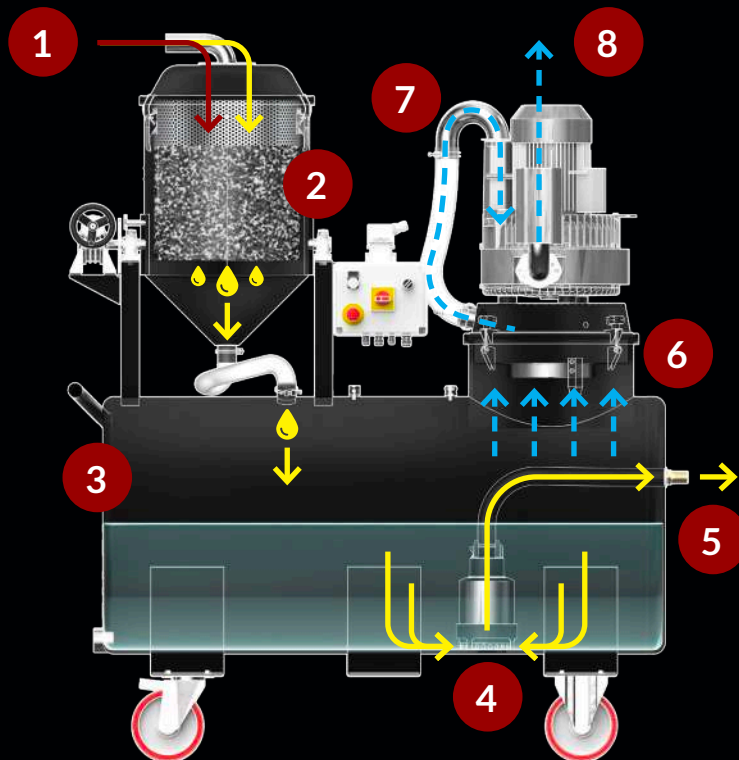

● Swarf ● Lubricant ● Air

HOW TO CHOOSE DISCHARGE SYSTEMS FOR LIQUIDS

**SIMULTANEOUS
SUCTION AND
DISCHARGE!**

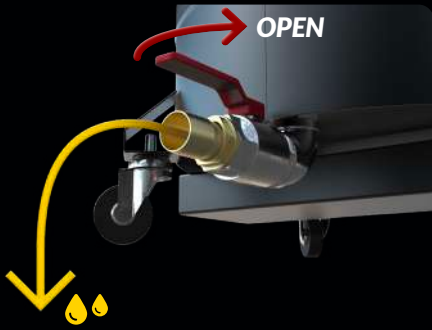

GRAVITY

The liquid is discharged by means of a manual ball valve placed at the bottom of the container.

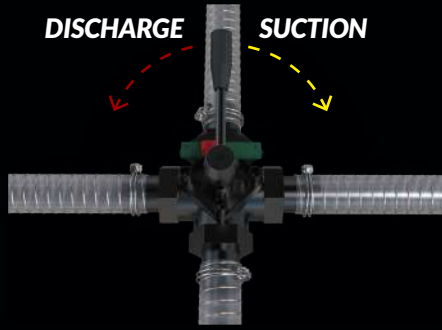

REVERSE FLOW

A practical lever, installed on the rear part of the vacuum cleaner, allows to rapidly select between vacuuming or discharging operation mode. The reverse flow system uses the exhaust air from the turbine, ensuring the efficiency and speed of the operation.

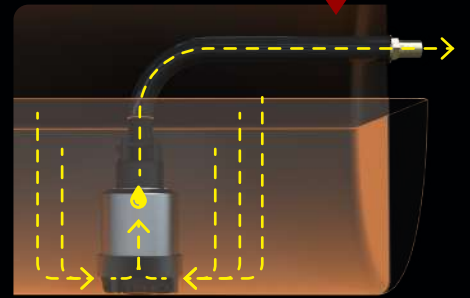

SUBMERGED PUMP

The vacuum cleaner is equipped with a submerged pump in order to empty the tank. The pump's level sensor automatically interrupts intake upon reaching maximum capacity. In the same way, the level sensor instructs the machine to interrupt discharge operations once minimum level is reached.

DISCHARGE SYSTEMS FOR SOLIDS



MANUAL

A metal basket is installed inside the vacuum container, retaining all the swarf and letting the collected oil fall. Thanks to the 2 handles it's easy to lift and empty the metal basket manually or by means of web slings.



HOPPER

Above the vacuum's tank is installed a tiltable hopper. A metal basket, paired with a PPL filter, is placed inside the hopper. The two act as a sieve, separating any solid particle eventually present from the vacuumed liquid and allowing a comfortable and safe discharge of the swarf

VACUUM UNITS



SINGLEPHASE MOTOR

Generate high vacuum performances, conceived for non-continuous use. Each motor is managed by an independent switch, allowing the operator to control suction performances.

- Powerful and highly reliable
- Long lasting life, up to 1300 hours



SIDE CHANNEL BLOWER

The suction unit is a side channel blower with direct coupling between motor and impeller.

The side channel blower is equipped with a safety valve to guarantee continued work in complete safety, without any maintenance.

- Continuous duty 24h and 7 days per week
- No need of maintenance

FILTERS



OIL PROOF CARTRIDGE

A filter designed to prevent the suction unit from being damaged by oil or other liquids that are being sucked up.



METAL BASKET WITH PPL FILTER

A PPL filter with a 150µ efficiency and a metal basket separate even the smallest solid particles, making the filtered liquid suitable for reuse. The PPL filter can be washed and reused easily.

EVERY VACUUM IS UNIQUE

Every Depureco vacuum has unique features to better suit your needs for your business. Choose the best combination to build your perfect Depureco Industrial Vacuum for the metalworking industry!



TANK CAPACITY

Choosing the right size tank size will fit your maintenance needs



OIL FILTRATION EFFICIENCY

To recover the largest quantity of oil possible



POWER SUPPLY

To perfectly adapt the product to your industry



DISCHARGE TYPE

To fit your disposal or recycling needs

OIL & SWAB INDUSTRIAL VACUUMS

OIL & SWARF OVERVIEW



- Standard
- Optional





	M 70 OIL	M 100 OIL	CLEAN OIL	FROG	RAM 250
MANUAL	■	■			
REVERSE FLOW			■	■	
PUMP FOR CONTINUOUS DISCHARGE	□			□	■
LIQUID CAPACITY	18 gal ■	26 gal ■	26 gal ■	34 gal ■	66 gal ■
SOLID CAPACITY	10 gal ■	13 gal ■	13 gal ■	11 gal ■	18 gal ■



RAM 280 MP	RAM 500 MP	RAM 500 T	RAM 500 T MP	RAM 1000 AV
				■
■	■	■	■	
74 gal	74 gal	132 gal	132 gal	264 gal
11 gal	11 gal	11 gal	18 gal	11 gal

M 70 OIL

Code: **A454/A454 P**

-  Power: 2.2 HP
-  Liquid capacity: 18 gal
Solid capacity: 10 gal
-  Suction time: 18 gal/18 sec
Discharge time: 18 gal/20 sec
-  Dimensions: in 28 X 18 X 57 h



P12355: Oil Kit PRO Ø2



P09679: PPL Filter (150 µ)
+ Metal separation basket



Manual discharge
by gravity

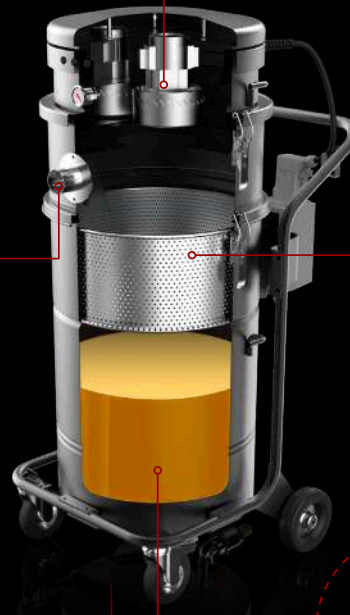





PUMP: Immersion
discharge pump



M 100 OIL

Code: **A455**

-  Power: 3.3 HP
-  Liquid capacity: 26 gal
Solid capacity: 13 gal
-  Suction time: 26 gal/26 sec
-  Dimensions: in 27 X 18 X 55 h



P12475: Oil proof
cartridge

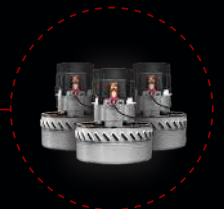

3 By-Pass motors



Scan the QR-Code
to watch the video

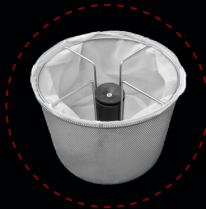

P09679: PPL Filter (150 µ)
+ Metal separation basket
+ Floating system to automatically stop suction



Tangential inlet with cyclone



Manual discharge
by gravity

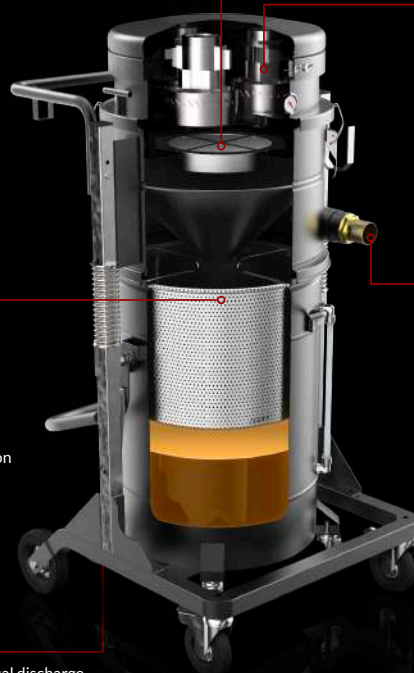

P12355: Oil Kit PRO Ø2

FROG



Power: 2.2 HP



Liquid capacity: 34 gal
Solid capacity: 11 gal



Suction time: 34 gal/30 sec
Discharge time: 34 gal/50 sec



Dimensions: in 28 X 47 X 52 h



Reverse Flow Discharge system



2 By-Pass motors



P12352: Oil Kit Ø2

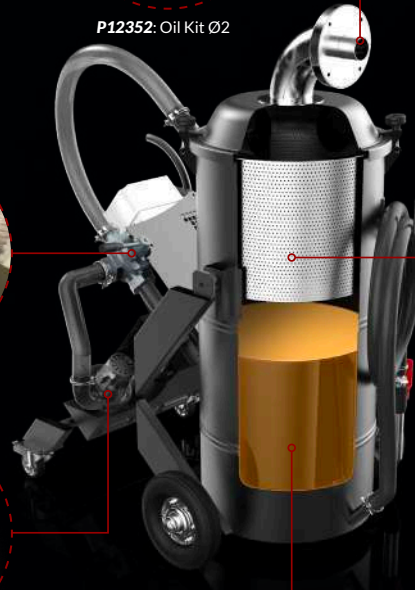

P09679: PPL Filter (150 µ)
+ Metal separation basket



PUMP: Immersion discharge pump

RAM OIL 280/500 MP



Power: 3.3 HP



Liquid capacity: 74/132 gal
Solid capacity: 11 gal



Suction time: 74 gal/60 sec
Discharge time: 74 gal/60 sec



Dimensions: in 28 X 57 X 55 h
in 24 X 59 X 55 h



P12352: Oil Kit Ø2



P12475: Oil proof cartridge

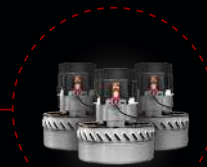

3 By-Pass motors



P09679: PPL Filter (150 µ)
+ Metal separation basket







PUMP: Immersion discharge pump



BIS: Inspection door

CLEAN OIL T

Code: **A450/US**

-  Power: 4.63 HP
-  Liquid capacity: 26 gal
Solid capacity: 13 gal
-  Suction time: 26 gal/26 sec
Discharge time: 26 gal/92 sec
-  Dimensions: in 33 X 28 X 64 h

 Scan the QR-Code to watch the video



Reverse Flow Discharge system



Side channel blower



P12475: Oil proof cartridge

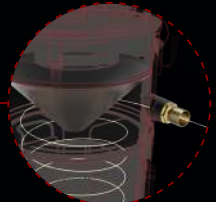

Tangential inlet with cyclone

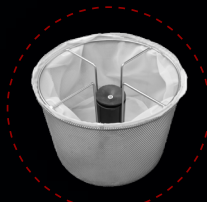





P09679: PPL Filter (150 µ)
+ Metal separation basket
+ Floating system to automatically stop suction



P12355: Oil Kit PRO Ø2

RAM OIL 250 T

Code: **A404/405**

-  Power: 4 HP
-  Liquid capacity: 66 gal
Solid capacity: 18 gal
-  Suction time: 66 gal/52 sec
Discharge time: 66 gal/100 sec
-  Dimensions: in 33 X 61 X 70 h



Tiltable discharging hopper



P12352: Oil Kit Ø2



P09679: PPL Filter (150 µ)
+ Metal separation basket



P12475: Oil proof cartridge



Side channel blower

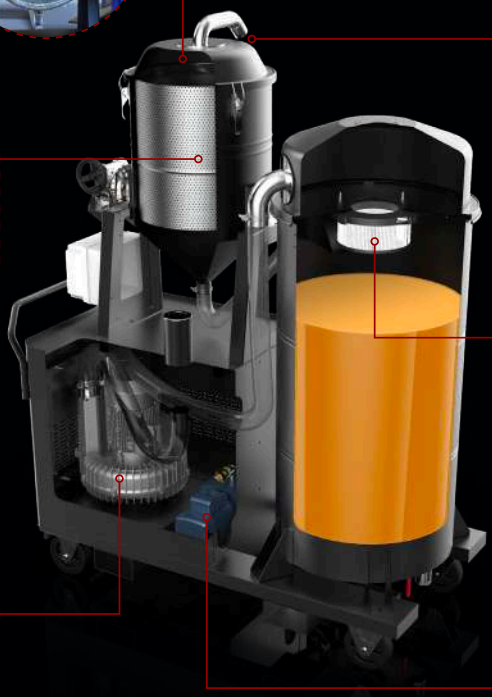





Discharge pump



RAM OIL T 500/T 500 MP

Code: A378/US | A406/US

-  Power: 6.5/3 HP
-  Liquid capacity: 132 gal
Solid capacity: 18 gal
-  Suction time: 132 gal/120 sec
Discharge time: 132 gal/120 sec
-  Dimensions: in 24 X 59 X 70 h



Scan the QR-Code to watch the video

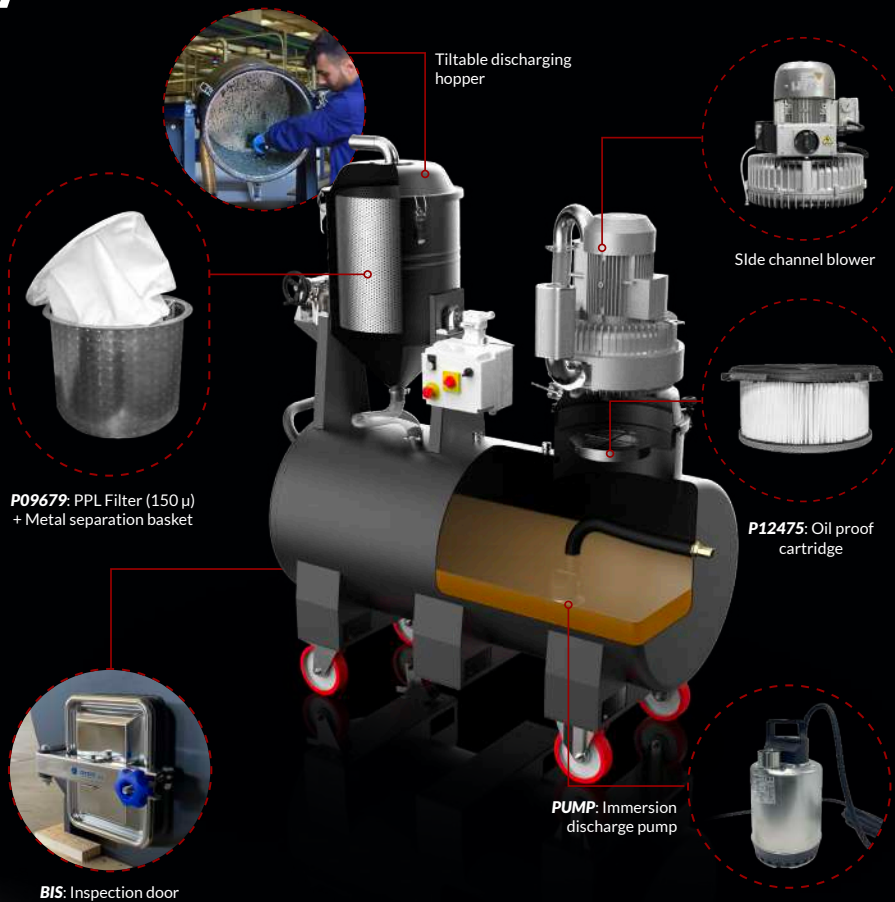

P09679: PPL Filter (150 µ) + Metal separation basket

BIS: Inspection door

Tiltable discharging hopper





Slide channel blower

P12475: Oil proof cartridge

PUMP: Immersion discharge pump

RAM OIL 1000 AV

Code: A379-001

-  Power: 7.5 HP
-  Liquid capacity: 264 gal
Solid capacity: 11 gal
-  Suction time: 264 gal/220 sec
Discharge time: 264 gal/240 sec
-  Dimensions: in 37 X 65 X 74 h



High Vacuum Pump with 354 inH₂O depression

BIS: Inspection door

Reverse Flow Discharge system

354 inH₂O

- Included

P12352: Oil Kit Ø2

P09679: PPL Filter (150 µ) + Metal separation basket

OIL & SWAB INDUSTRIAL VACUUMS

TECHNICAL DATA



Technical data	Units	M 70 Oil / P	M 100 Oil	Clean Oil T	Frog Oil	Ram 250 T
Code		A454 A454 P	A455	A450/US	A386	A404/US
Motor type		2 By-Pass	3 By-Pass	Side Channel Blower	2 By-Pass	Side Channel blower
Power	HP	2.2	3.3	4.63	2.2	4
Voltage Frequency	V Hz	110 60	110 60	480 60	110 60	480 60
IP Insulation class		---	---	55 F	---	55 F
Maximum vacuum	inH ₂ O	98	98	90	98	116
Vacuum in continuous run	inH ₂ O	---	---	80	---	104
Maximum air flow	CFM	224	336	300	224	198
Suction time	gal/sec	18/18	26/26	26/26	34/30	66/50
Dumping time	gal/sec	18/20	---	26/92	34/50	66/100
Suction inlet	Ø in	2	2	2	2	2
Noise level - (EN ISO 3744)	dB (A)	70	72	78	70	72
Liquid capacity	gal	18	26	26	34	66
Solid capacity	gal	10	13	13	11	18
Dimensions	in	28 X 18 X 57 h	27 X 18 X 55 h	27 X 18 X 55 h	28 X 47 X 52 h	33 X 61 X 70 h
Weight	lb	198	198	242	209	485
Primary discharge type		Gravity	Gravity	Reverse flow	Reverse flow	Discharge pump
Optional discharge type		Discharge pump	---	---	Discharge pump	---
Primary filter						
Type		Oil Proof cartridge	Oil Proof cartridge	Oil Proof cartridge	---	Oil Proof cartridge
Secondary Filter						
Type		PPL Filter	PPL Filter	PPL Filter	PPL Filter	PPL Filter



Ram 280 MP	Ram 500 MP	Ram 500 T	Ram 500 T MP	Ram 1000 AV
A373/US	A730/US	A378/US	A406/US	A379-001
3 By-Pass	3 By-Pass	Side Channel Blower	Side Channel Blower	Rotary vane pump
3.3	3.3	6.5	3.3	7.5
110 60	110 60	480 60	480 60	480 60
---	---	55 F	55 F	55 F
98	98	160	98	354
---	---	138	---	314
336	336	180	336	176
74/63	132/63	132/120	132/120	264/220
74/60	132/60	132/120	132/120	264/240
2	2	2	2	2
72	72	72	72	82
74	132	132	132	264
11	11	18	18	11
28 X 57 X 55 h	24 X 59 X 55 h	24 X 59 X 70 h	24 X 59 X 70 h	37 X 65 X 74 h
485	650	705	705	1015
Discharge pump	Discharge pump	Discharge pump	Discharge pump	Reverse flow
---	---	---	---	---
Oil Proof cartridge	Oil Proof cartridge	Oil Proof cartridge	Oil Proof cartridge	---
PPL Filter	PPL Filter	PPL Filter	PPL Filter	PPL Filter

ACCESSORIES

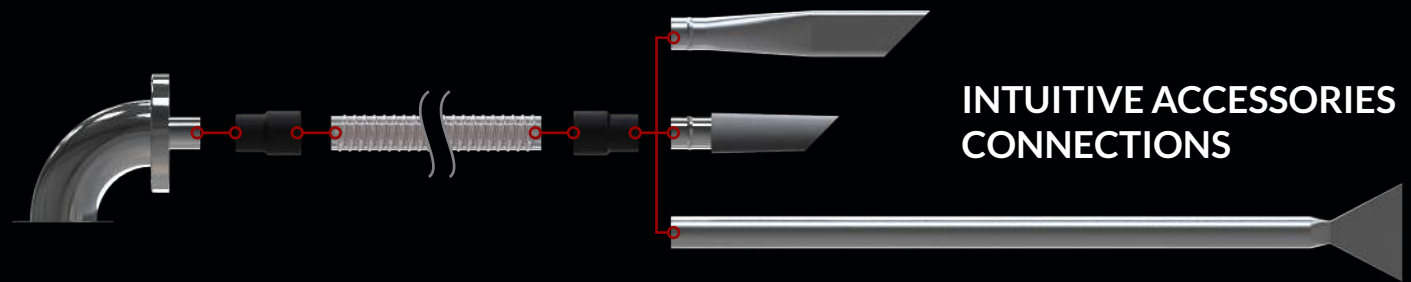

INTUITIVE ACCESSORIES CONNECTIONS

ACCESSORIES KIT



P12352

2 in

Oil & Swarf
KIT Ø2



P12355

2 in

Oil & Swarf
KIT PRO Ø2

CONNECTIONS



P09214

2 in

Rubber sleeve for
hoses

FINAL ACCESSORIES

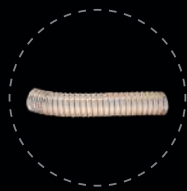

P11933/50

2 in

Reinforced abrasion
proof hose



P00329

2 in

Scraping suction pipe



P00301

2 in

Flat pipe



P10410

2 in

Oil proof rubber
scraper



P00308

2 in

Oil proof rubber
conic nozzle



P00649

2 in

"S" Handgrip for floor
brush



P00783

2 in

Extension pipe
with handle



P01038

2 in

Floor squedgee with
rubber strips

OPTIONALS



P09679

PPL filter
150 μ efficiency



P09678

TNT disposable filter



P12475

Oil proof cartridge



PUMP

Continuous
discharge pump



BIS

Inspection door

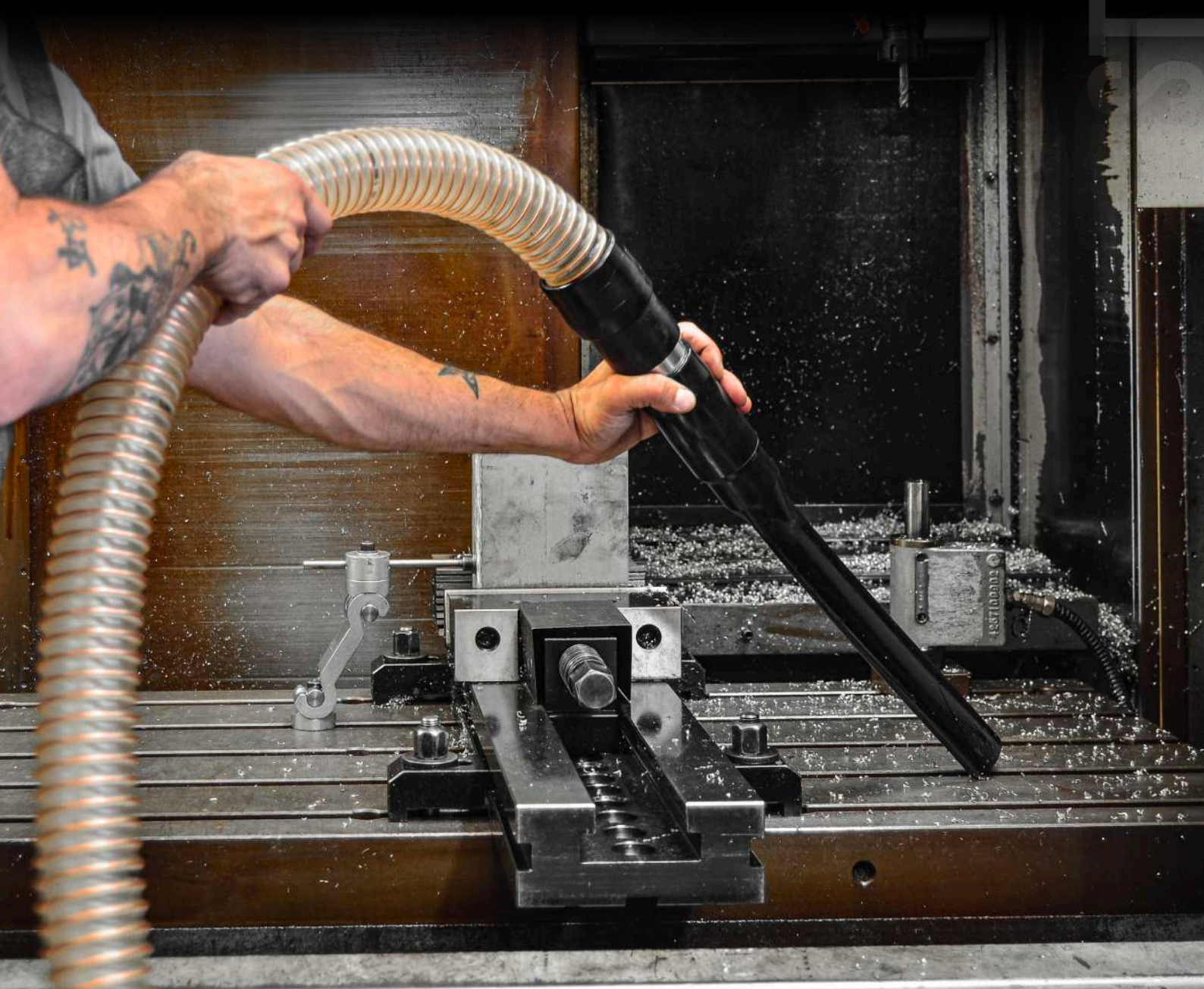

DEPURECO SOLUTIONS FOR METALWORKING INDUSTRY



ADDITIVE MANUFACTURING

Industrial Vacuum Systems essential for post-processing operations and maintenance, ensuring high-quality production and reducing the risk of equipment damage.

CNC ROOM

Industrial vacuum systems for CNC machinery applications, providing efficient and reliable removal of oil, coolant and oil mists to maintain optimal operating and environment conditions, extending the lifespan of the equipment.

SANDBLASTING

Solutions providing efficient recovery of sand or steel grit, improving safety and effectiveness of the processes.

METALWORKING

Highly efficient, large collection and cost-effective solutions for keeping workspaces clean and safe.

WAREHOUSE

Versatile and effective solutions for general cleaning or overhead applications offer powerful suction and filtration capabilities to maintain clean and safe workspaces.

WELDING

Solutions to effectively capture and remove hazardous welding fumes and particulates, promoting a safer and healthier work environment.

INDUSTRIAL PAINTING

Vacuum solutions providing effective removal of overspray, dust, and debris, resulting in high-quality finishes and reduced contamination, ensuring a safe and healthy work environment.

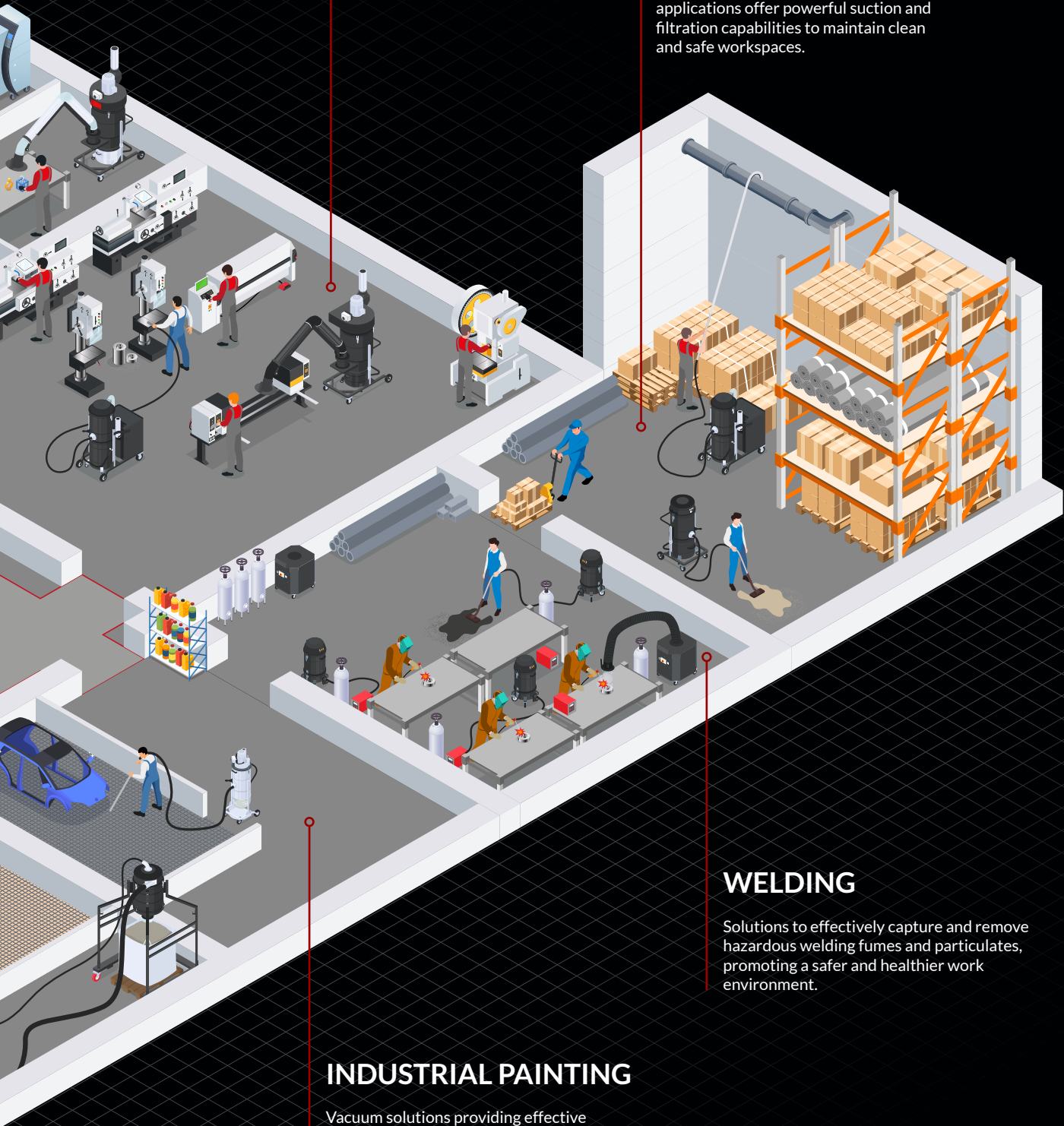

MORE THAN 180
INDUSTRIAL VACUUMS
DISCOVER THEM ON
DEPURECO.COM







19121 Marketplace Avenue
Building 1, Suite 165
Plum Creek Business Park
Kyle, Texas 78640

Phone 737 70 44 347
www.depureco.com
depureco@depureco.com

